

Installation Instruction

FEATURES

1. Weather proof.
2. Efficient Installation capability

SPECIFICATION PARAMETER

Model	HIGH LED 2		
Dimension (mm)	650*127*86mm, 1260*127*86mm, 1560*127*86mm		
Luminous Flux(lm)	2640lm,5760lm, 6600lm		
Input Voltage	AC220-240V	Frequency	50/60Hz
Input Wattage	22W, 48W, 55W	Protection Grade	IP65
Work Temperature	-20 to 40℃	CCT	3000K&4000K&6500K
Beam Angle	120°		

CAUTION

Please make sure the power off and read this instruction before installation. And make sure the fixture can work well under the specification. If you have not electrical experience, you must let a qualified licensed electrician help you installed.

When taking the luminaires, don't seize the power cables directly by hand, and the luminaires should not be hung from the power cables; the luminaire's weight should not cause mechanical tension in the wires.

Dimension:

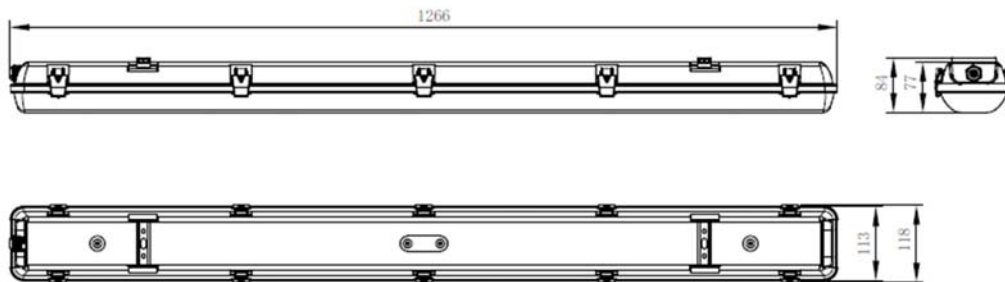

INSTALLATION INSTRUCTION

I

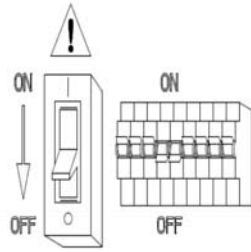

II

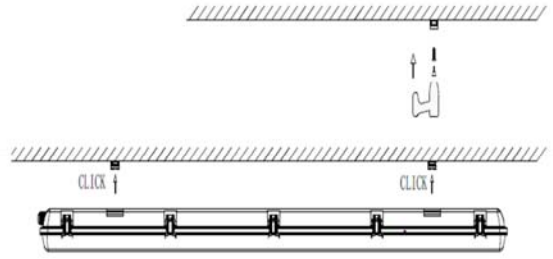

III

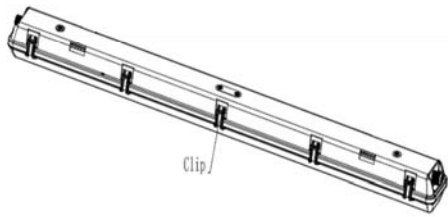

IV

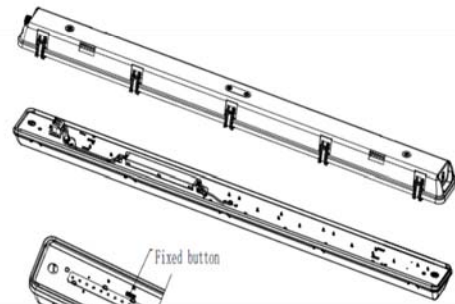

V

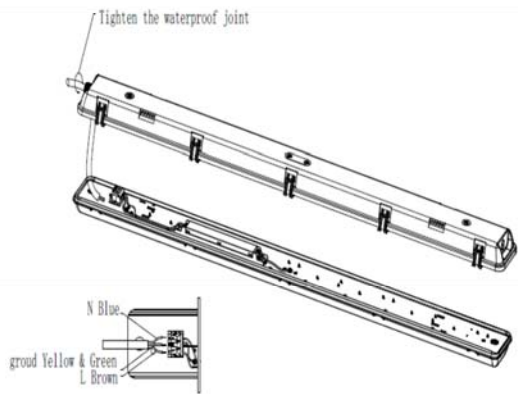

VI

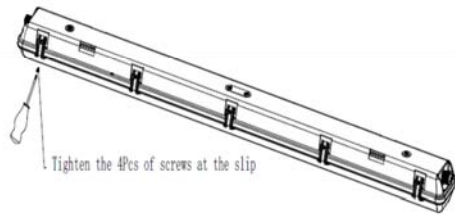

VII

